

pco.edge 5.5

scientific CMOS camera

low noise
1.0 electrons

high resolution
2560 x 2160 pixel



lightsheet
scanning
mode

USB 3.0
Camera Link

CAMERA
LinkHS™

small
form factor

high dynamic range
30 000:1

high speed
100 fps

high quantum efficiency
> 60 %

features

Selectable rolling shutter operation modes of pco.edge cameras.

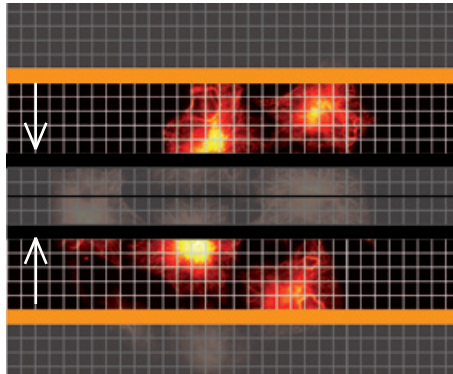

dual outside in

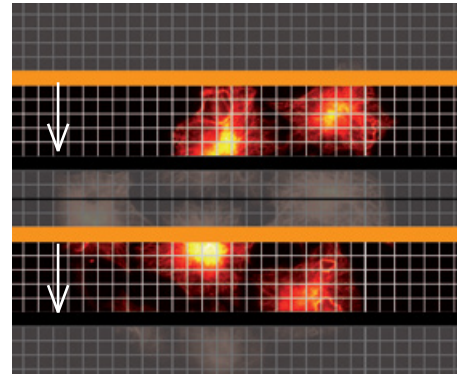

dual top down

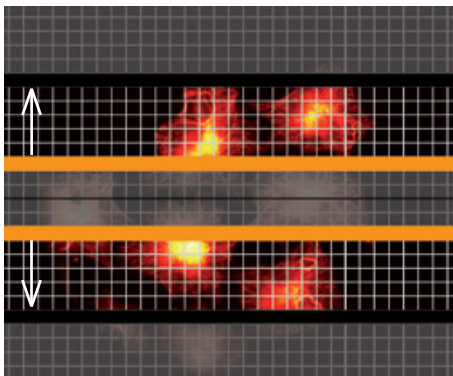

dual inside out

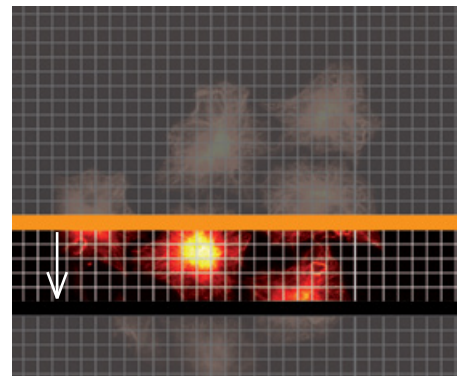

single top down

rolling shutter readout modes – optimized for synchronization of microscopes and scanning applications

All pco.edge sCMOS cameras from the beginning feature a variety of precise synchronization modes, which are optimized for advanced microscopy imaging and scanning. The flexible frame and line triggers with very low latency in combination with the free selectable readout modes can easily be combined to cover every modern microscopy situation to name a few:

- lightsheet microscopy
- selective plane imaging microscopy (SPIM)
- structured illumination microscopy
- localizations microscopy (GSD, PALM, STORM, dSTORM)
- spinning disk confocal microscopy
- RESOLFT

For example, one mode is used in a lightsheet or SPIM application, the lower right rolling shutter operational mode “single top down” operation is convenient to properly synchronize the camera exposure with the scanner. On the other hand, if speed is required and a flash like exposure is applied the upper left mode “dual outside in” is used for localization microscopy techniques like GSD, PALM or STORM.

features

free of drift

The pco.edge sCMOS cameras feature temperature stabilized Peltier cooling, allowing for continuous operation free of drift phenomena in image sequences capture. This is achieved by the proper selection and sophisticated combination of electronics and FPGA algorithms.

As the measurement result shows while running at full speed of 100 frames/s over 4 hours measuring time the camera doesn't show any significant drift (figure on the right side). This degree of stability enables long-term measuring series, which should be quantitatively evaluated and processed. For example, in PCR (Polymerase Chain Reaction) applications, when so-called melting curves must be measured, the fluorescence in multi-well plates with different samples is recorded over a longer time at different sample temperatures. Here all the images are used for processing, which is only possible if the offset is stable and the camera is free of drift.

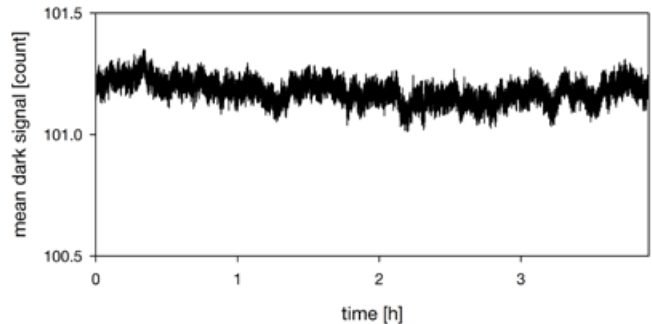

Mean dark signal drift measurement of a pco.edge camera stabilized at +5 °C over a 4 hour period recorded at 100 frames/s (1 count = 0.5 electron).

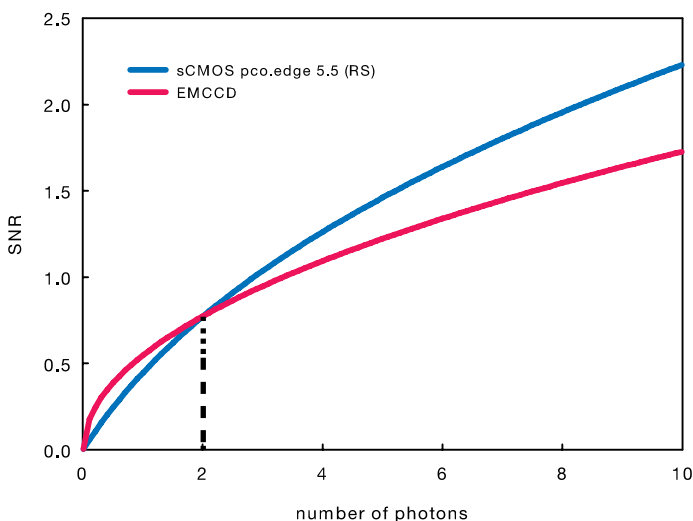

reaching emCCD domain

In the past emCCD image sensors featuring on-chip amplification were developed to detect the lowest level of light. However, amplification, while reducing read out noise, comes at the expense of dynamic range. Both features are not possible simultaneously in emCCD sensors. In addition, the amplification process generates excess noise, which reduces the effective quantum efficiency (QE_{eff}) of the emCCD sensor by the factor of two (e.g. the 90 % QE of a back illuminated emCCD sensor has an QE_{eff} of 45 %). The excess noise present in emCCDs makes the pco.sCMOS the sensor of choice at light conditions above 2 photons per pixel (at 60 % QE, assuming a cooled sensor with dark current = 0). Furthermore, available emCCD sensors are limited in resolution and frame rate.

features

readout noise in sCMOS

The EMVA 1288 standard explains that in principle for each pixel in an image sensor the noise behavior is determined by recording many images and calculating the time dependent variation or deviation of each pixel from its mean value. This is the determination of the root mean square (rms) value for each pixel. Since the widely used CCD image sensors don't have a separate output stage for each pixel, the variation of the noise between each pixel is minimal. Therefore, instead of measuring many images, it is sufficient to measure two images, calculate the variance for each pixel and average these variances within the image to obtain an rms value for the image sensor. For CCD image sensors this simplification is a good approximation and has been now for years to describe the readout noise of image sensors in general.

However, CMOS image sensors, including scientific CMOS image sensors, feature a different behavior such that the simplified rms determination with the averaging across the whole image sensor is not sufficient to describe the noise behavior. The figure top right shows the result of time series of dark images, where for each pixel an rms value is calculated along the time axis and the results are shown in this histogram, showing the readout noise distribution for the total image sensor. Since two different pixel clocks are available in turn two curves are provided.

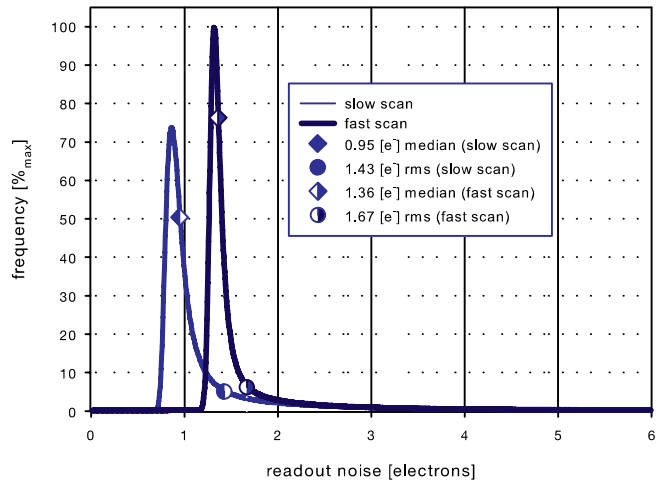

Noise distribution of the rms raw data values (noise filter off) of each pixel in the dark image of a pco.edge 5.5 at different readout speeds (slow scan / fast scan).

A valuable characterization of these rms value distributions is the so called median value, which is the point where 50% of all values are larger and smaller. For comparison the rms value measured by the simplified EMVA1288 approach is given. For a CCD image sensor these values would be identical, but for CMOS image sensors they start to diverge. For comparison of different cameras and image sensors both values can be used. For practical use it should be considered, that these values are calculated from a large series of recorded images.

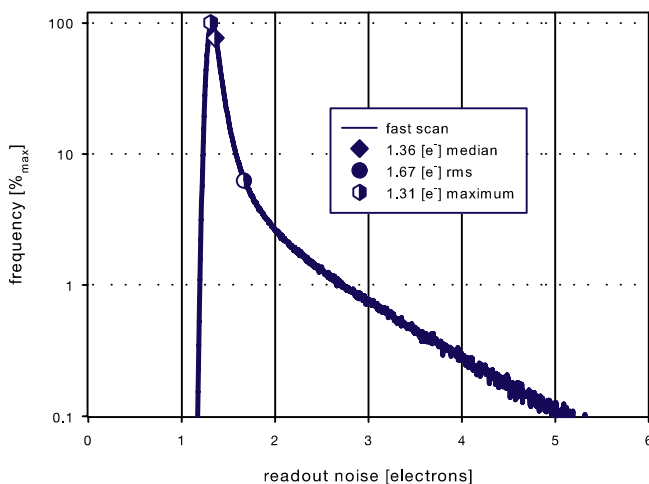

The left figure shows the same fast scan curve of the pco.edge 5.5 only in a logarithmic y-axis (frequency) scaling, to emphasize that most of the pixels have an average readout noise in time that is smaller than 1.5 electron and there are few pixels (less than 1 % of the maximum), which have a readout noise of 3 – 6 electrons.

Noise distribution of the rms raw data values (noise filter off) of each pixel in the dark image of a pco.edge 5.5 at the fast readout speed. Graph is identical to figure on the top but in logarithmic y- axis scaling.

features

superior image quality

The new pco.edge camera (with scientific CMOS image sensor) features outstanding low read out noise of 1.0 electrons (e⁻) med. Even at maximum speed of 100 frames/s at full resolution of 2560 x 2160 pixel the noise is 1.1 e⁻ med. Moreover the pco.edge provides an excellent homogeneous pixel response to light (PRNU, photo response non-uniformity) and an excellent homogeneous dark signal pixel behaviour (DSNU, dark signal non-uniformity), which is achieved by a sophisticated electronic circuit technology and firmware algorithms. The lower figure shows a comparison of a scientific grade CCD and the new pco.sCMOS image sensor under similar weak illumination conditions. This demonstrates the superiority of pco.sCMOS over CCD with regards to read out noise and dynamic, without any smear (the vertical lines in the CCD image).

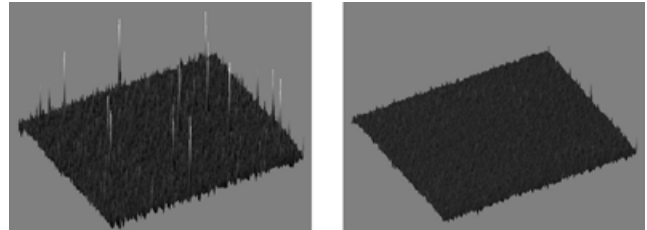

Dark image comparison with the measured distribution of “hot blinking” pixels at 5°C of the image sensor. The left image gives a 3D view with the sophisticated “blinker filter” algorithm off and the right image shows the result with the filter switched on.

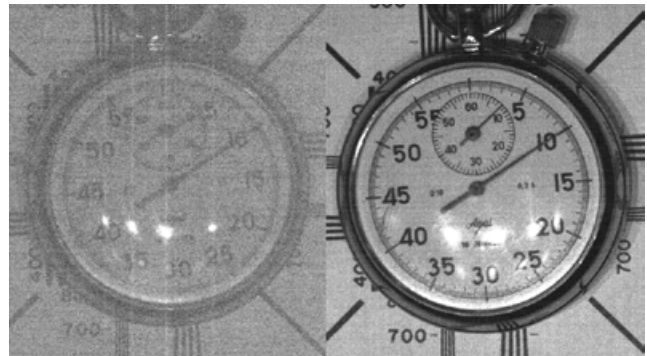

The left image was recorded by a scientific CCD camera while the right image was recorded by a pco.edge under identical conditions.

flexibility and free of latency

User selectable choice of rolling or global shutter mode for exposure provides flexibility for a wide range of applications. The advantages of rolling shutter are high frame rates and low read out noise whereas global shutter provides snapshot images for fast moving objects. In Camera Link Version due to realtime transmission of the image data to the PC, there is no latency between recording and access or storage of the data.

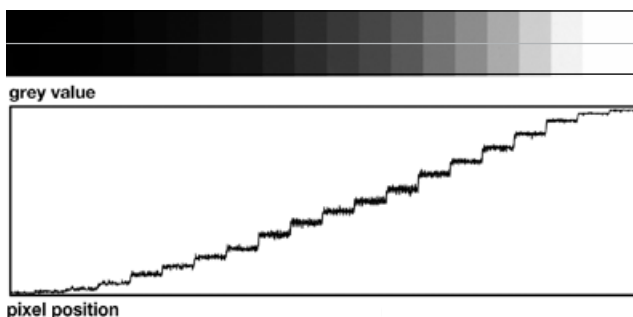

The top image shows an extract of a typical pco.edge recording of a grey scale with a 1 : 10 000 dynamic in 20 steps. The bottom image is a plot of the grey values profile along the centered line through the top image (with gamma 2.2).

30 000:1 dynamic range

Due to the excellent low noise and the high fullwell capacity of the sCMOS image sensor an intra scene dynamic range of better than 30 000 : 1 is achieved. A unique architecture of dual column level amplifiers and dual 11 bit ADCs is designed to maximize dynamic range and to minimize read out noise simultaneously. Both ADC values are analyzed and merged into one high dynamic 16 bit value.

features

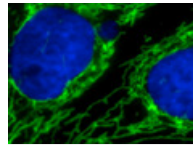
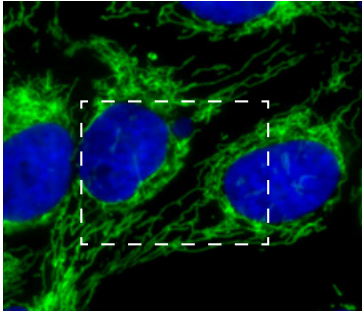

The two images show in comparison the field of view of a 5.5 Mpixel resolution vs. a 1.3 Mpixel resolution, courtesy of Dr. Stefan Jakobs, Dept. of NanoBiophotonics, MPI for Biophysical Chemistry

high resolution

A 5.5 Mpixel resolution in combination with a moderate chip size (21.8 mm diagonal, 6.5 μm pixel pitch) benefits microscopy applications with low magnification factor and large field of view, thereby reducing processing times and increasing throughput. The figure compares the potential of the new field of view of the pco.edge to the 1.3 Mpixel image resolution which is widely used in microscopy applications for scientific cameras.

high speed recording and data streaming

The new pco.edge offers in fast mode a frame rate of 100 frames/s (fps) at full resolution of 2560 x 2160 pixel as a full download stream to the PC. Therefore the recording time is just limited by either the amount of RAM in the PC or, in case of a RAID system, by the capacity and number of hard disks. As in many CMOS based cameras the frame rate increases significantly if smaller regions of interest (ROI) are used. The reduction of the image area works as well in favour of the frame rate of CCD sensors, but here unwanted regions still need to be read out at the expense of the total readout speed. The typical frame rate for a 1.3 Mpixel scientific CCD camera (6 e- read out noise) is 10 fps. The new pco.edge camera provides at 1.3 Mpixel resolution (< 2 e- read out noise) a frame rate of 210 fps in comparison.

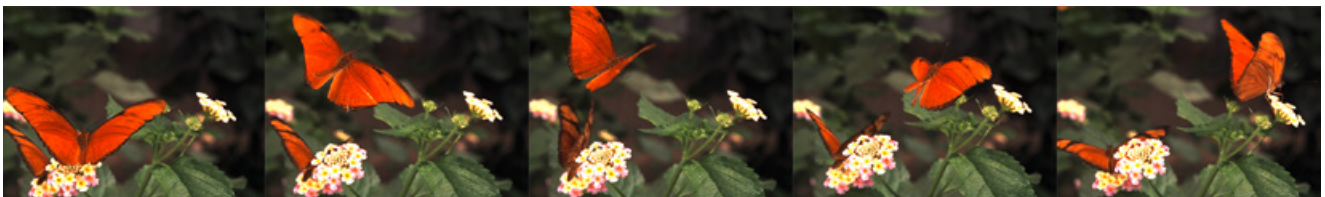

Resolution 640 x 480 pixel @ 400 frames/s (color version)

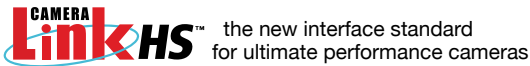

What is Camera Link HS?

Camera Link HS (CLHS) is designed to specifically meet the needs of vision and imaging applications. It provides low latency, low jitter, real-time signals between a camera and a frame grabber while carrying image data, control data and trigger events. The interface builds upon the key strengths of Camera Link by adding new features and functions to meet the needs of today and tomorrow. Camera Link HS is designed as a system ensuring that CMOS sensor technology can be fully exploited, while providing cost effective cameras and frame grabbers that are easy to use, flexibility and provide reliability data demanded by customers¹.



Benefits



More bandwidth

- Effective bandwidth of about 1187 MB/s (CLHS X-Protocol - 10G) equals roughly three times a USB 3.1 Gen1 bandwidth & equals netto data rate of CoaXPRESS CXP-12

More robust connection

- No communication error at a Bit Error Rate (BER) of 10^{-12} because of using a Forward Error Correction algorithm (FEC)
- Forward Error Correction corrects burst errors of up to 11 Bits on the fly
- FEC technology supersedes packet resend mechanism for data reliability
- Fiber Optic Link (FOL) provides high resistance to EMC and allows long cable lengths with the best signal integrity

More distance

- Cable length more than 300m using multimode fiber
- Cable length more than 10km with single mode fiber

More flexibility

- Real-time trigger over cable with extremely low jitter
- Plug and Play with GenICam and GenCP
- Using standard LC-connector for flexible cable decision



More open

- The full CLHS specification is downloadable for free
- AIA IP-core is available for fast compliant FPGA implementation (Xilinx, Altera, Lattice)

More cost effective

- The use of standard network hardware components such as enhanced small form-factor pluggable (SFP+) connector from multiple vendors allows multi sourcing
- Inexpensive licensing

¹ <http://www.visiononline.org/vision-standards-details.cfm?type=10>

technical data Camera Link HS

image sensor

type of sensor	scientific CMOS (sCMOS)
image sensor	CIS2521
resolution (h x v)	2560 x 2160 active pixel
pixel size (h x v)	6.5 μm x 6.5 μm
sensor format / diagonal	16.6 mm x 14.0 mm / 21.8 mm
shutter modes	rolling shutter (RS) with free selectable readout modes, global/snapshot shutter (GS), global reset - rolling readout (GR)
MTF	76.9 lp/mm (theoretical)
fullwell capacity (typ.)	30 000 e ⁻
readout noise ¹	1.0 _{med} / 1.4 _{rms} e ⁻ @ RS/GR, slow scan ² 1.1 _{med} / 1.5 _{rms} e ⁻ @ RS/GR, fast scan ² 2.2 _{med} / 2.5 _{rms} e ⁻ @ GS, fast scan
dynamic range (typ.)	30 000 : 1 (89.5 dB) RS, slow scan
quantum efficiency	> 60 % @ peak
spectral range	370 nm .. 1100 nm
dark current (typ.)	< 0.6 e ⁻ /pixel/s RS/GR @ 7 °C < 0.9 e ⁻ /pixel/s GS @ 7 °C
DSNU	< 0.3 e ⁻ rms RS slow scan < 3.9 e ⁻ rms GS fast scan < 0.3 e ⁻ rms RS fast scan
PRNU	< 0.34 %
anti blooming factor	> 10 000

frame rate table³

typical examples	RS fast scan	GS	RS slow scan
2560 x 2160	100 fps	50 fps	33 fps
2560 x 1024	212 fps	105 fps	70 fps
2560 x 512	422 fps	208 fps	140 fps
2560 x 256	838 fps	409 fps	279 fps
2560 x 128	1651 fps	789 fps	550 fps
1920 x 1080	201 fps	100 fps	67 fps
1600 x 1200	181 fps	90 fps	60 fps
1280 x 1024	212 fps	105 fps	70 fps
640 x 480	450 fps	222 fps	150 fps
320 x 240	893 fps	436 fps	297 fps

¹ The readout noise values are given as median (med) and root mean square (rms) values, due to the different noise models, which can be used for evaluation.

² Raw data without filtering.

³ Max. fps with centered ROI.

⁴ The high dynamic signal is simultaneously converted at high and low gain by two 11 bit A/D converters and the two 11 bit values are sophisticatedly merged into one 16 bit value.

camera

frame rate	100 fps @ RS/GR, fast scan @ 2560 x 2160 pixel 50 fps @ GS, fast scan
exposure / shutter time	500 μs .. 2 s RS 10 μs .. 100 ms GS 10 μs .. 2 s GR
dynamic range A/D ²	16 bit
A/D conversion factor	0.46 e ⁻ /count
pixel scan rate	286.0 MHz fast scan RS & GS & GR 100.0 MHz slow scan RS & GR
pixel data rate	572.0 Mpixel/s 200.0 Mpixel/s
binning horizontal	x1, x2, x4
binning vertical	x1, x2, x4
region of interest (ROI)	horizontal: steps of 16 pixels vertical: steps of 1 pixels
non-linearity	< 0.6 %
cooling method	+ 7 °C stabilized peltier with forced air (fan) (up to 27°C ambient)
trigger input signals	frame trigger, sequence trigger, programmable input (SMA connectors)
trigger output signals	exposure, busy, line, programmable output (SMA connectors)
data interface	Camera Link HS (Single-F2,1X1,S10)
time stamp	in image (1 μs resolution)

general

power supply	12 .. 24 VDC (+/- 10 %)
power consumption	32 W max. (typ. 19W @ 20 °C)
weight	1010 g with F-mount
operating temperature	+ 10 °C .. + 40 °C
operating humidity range	10 % .. 80 % (non-condensing)
storage temperature range	- 10 °C .. + 60 °C
optical interface	F-mount & C-mount
CE / FCC certified	yes



technical data Camera Link

image sensor

type of sensor	scientific CMOS (sCMOS)
image sensor	CIS2521
resolution (h x v)	2560 x 2160 pixel
pixel size (h x v)	6.5 µm x 6.5 µm
sensor format / diagonal	16.6 mm x 14.0 mm / 21.8 mm
shutter modes	rolling shutter (RS) with free selectable readout modes, e. g. lightsheet scanning mode ¹ global/snapshot shutter (GS), global reset - rolling readout (GR)
MTF	76.9 lp/mm (theoretical)
fullwell capacity (typ.)	30 000 e ⁻
readout noise ²	1.1 _{med} / 1.5 _{rms} e ⁻ @ RS/GR, slow scan ³ 1.5 _{med} / 1.7 _{rms} e ⁻ @ RS/GR, fast scan ³ 2.2 _{med} / 2.5 _{rms} e ⁻ @ GS, fast scan
dynamic range (typ.)	27 000 : 1 (88.6 dB) RS, slow scan
quantum efficiency	> 60 % @ peak
spectral range	370 nm .. 1100 nm
dark current (typ.)	< 0.5 e ⁻ /pixel/s RS/GR @ 5 °C < 0.8 e ⁻ /pixel/s GS @ 5 °C
DSNU	< 1.0 e ⁻ rms RS slow scan 3.9 e ⁻ rms GS fast scan < 2.0 e ⁻ rms RS fast scan
PRNU	< 0.5 %
anti blooming factor	> 10 000

frame rate table⁴

typical examples	RS fast scan	GS	RS slow scan
2560 x 2160	100 fps	50 fps	33 fps
2560 x 1024	212 fps	105 fps	70 fps
2560 x 512	422 fps	208 fps	140 fps
2560 x 256	838 fps	409 fps	279 fps
2560 x 128	1651 fps	789 fps	550 fps
1920 x 1080	201 fps	100 fps	67 fps
1600 x 1200	181 fps	90 fps	60 fps
1280 x 1024	212 fps	105 fps	70 fps
640 x 480	450 fps	222 fps	150 fps
320 x 240	893 fps	436 fps	297 fps

¹ Selectable via SDK (software development kit).

² The readout noise values are given as median (med) and root mean square (rms) values, due to the different noise models, which can be used for evaluation. All values are raw data without any filtering.

³ Raw data without filtering.

⁴ Max. fps with centered ROI.

⁵ The high dynamic signal is simultaneously converted at high and low gain by two 11 bit A/D converters and the two 11 bit values are sophisticatedly merged into one 16 bit value.

⁶ Visually lossless compression / decompression for data transfer in fast scan mode and horizontal resolution greater than 1920 pixel (due to Camera Link limitations).

⁷ Available for rolling shutter (RS).

camera

frame rate	100 fps @ RS/GR, fast scan @ 2560 x 2160 pixel 50 fps @ GS, fast scan
exposure / shutter time	500 µs .. 2 s RS 10 µs .. 100 ms GS 10 µs .. 2 s GR
dynamic range A/D ^{5, 6}	16 bit
A/D conversion factor	0.46 e ⁻ /count
pixel scan rate	286.0 MHz fast scan RS & GS 95.3 MHz slow scan RS
pixel data rate	572.0 Mpixel/s 190.7 Mpixel/s
binning horizontal ⁷	x1, x2, x4
binning vertical ⁶	x1, x2, x4
region of interest (ROI)	horizontal: steps of 4 pixels vertical: steps of 1 pixels
non-linearity	< 1 %
cooling method	+ 5 °C stabilized selectable: peltier with forced air (fan) or water cooling (both up to 27°C ambient)
trigger input signals	frame trigger, sequence trigger, programmable input (SMA connectors)
trigger output signals	exposure, busy, line, programmable output (SMA connectors)
data interface	Camera Link Full (10 taps, 85 MHz)
time stamp	in image (1 µs resolution)

general

power supply	12 .. 24 VDC (+/- 10 %)
power consumption	20 W max. (typ. 10 W @ 20 °C)
weight	700 g
operating temperature	+ 10 °C .. + 40 °C
operating humidity range	10 % .. 80 % (non-condensing)
storage temperature range	- 10 °C .. + 60 °C
optical interface	F-mount & C-mount
CE / FCC certified	yes



technical data USB 3.0

image sensor

type of sensor	scientific CMOS (sCMOS)
image sensor	CIS2521
resolution (h x v)	2560 x 2160 pixel
pixel size (h x v)	6.5 μm x 6.5 μm
sensor format / diagonal	16.6 mm x 14.0 mm / 21.8 mm
shutter modes	rolling shutter (RS) with free selectable readout modes, global/snapshot shutter (GS), global reset - rolling readout (GR)
MTF	76.9 lp/mm (theoretical)
fullwell capacity (typ.)	30 000 e ⁻
readout noise ¹	1.0 _{med} / 1.4 _{rms} e ⁻ RS/GR ² 3.1 _{med} / 3.2 _{rms} e ⁻ GS
dynamic range (typ.)	30 000 : 1 (89.5 dB)
quantum efficiency	> 60 % @ peak
spectral range	370 nm .. 1100 nm
dark current (typ.)	< 0.5 e ⁻ /pixel/s RS/GR @ 5 °C < 0.8 e ⁻ /pixel/s GS @ 5 °C
DSNU	< 0.3 e ⁻ rms RS/GR < 2.0 e ⁻ rms GS
PRNU	< 0.2 %
anti blooming factor	> 10 000

frame rate table³

typical example	GS	RS
2560 x 2160	28 fps	30 fps
2560 x 1024	59 fps	63 fps
2560 x 512	117 fps	126 fps
2560 x 256	232 fps	248 fps
2560 x 128	455 fps	481 fps
1920 x 1080	56 fps	60 fps
1600 x 1200	50 fps	54 fps
1280 x 1024	59 fps	63 fps
640 x 480	125 fps	134 fps
320 x 240	247 fps	264 fps

camera

frame rate	30 fps
@ 2560 x 2160 pixel	
exposure / shutter time	500 μs .. 2 s RS 20 μs .. 100 ms GS 30 μs .. 2 s GR
dynamic range A/D ⁴	16 bit
A/D conversion factor	0.46 e ⁻ /count
pixel scan rate	86.0 MHz RS 160.0 MHz GS
pixel data rate	172.0 Mpixel/s RS 320.0 Mpixel/s GS
binning horizontal	x1, x2, x4
binning vertical	x1, x2, x4
region of interest (ROI)	horizontal: steps of 4 pixels vertical: steps of 1 pixel
non-linearity	< 0.6 %
cooling method	+5 °C stabilized, peltier with forced air (fan) / water cooling (both up to 27°C ambient)
trigger input signals	frame trigger, programmable input (SMA connectors)
trigger output signals	exposure, busy, line, programmable output (SMA connectors)
data interface	USB 3.0
time stamp	in image (1 μs resolution)

general

power supply	12 .. 24 VDC (+/- 10 %)
power consumption	21 W max. (typ. 12 W @ 20 °C)
weight	930 g
operating temperature	+ 10 °C .. + 40 °C
operating humidity range	10 % .. 80 % (non-condensing)
storage temperature range	- 10 °C .. + 60 °C
optical interface	F-mount & C-mount
CE / FCC certified	yes

¹ The readout noise values are given as median (med) and root mean square (rms) values, due to the different noise models, which can be used for evaluation. All values are raw data without any filtering.

² Raw data without filtering.

³ Max. fps with centered ROI.

⁴ The high dynamic signal is simultaneously converted at high and low gain by two 11 bit A/D converters and the two 11 bit values are sophisticatedly merged into one 16 bit value.



technical data

quantum efficiency

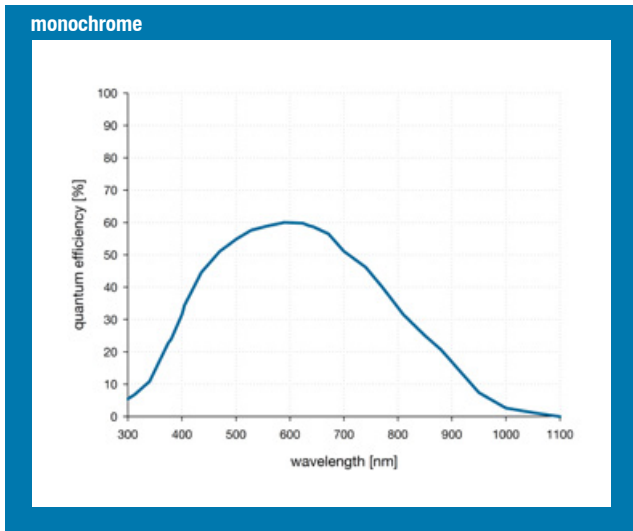

camera views



Camera Link HS



Camera Link



USB 3.0

dimensions

F-mount and C-mount lens changeable adapter.

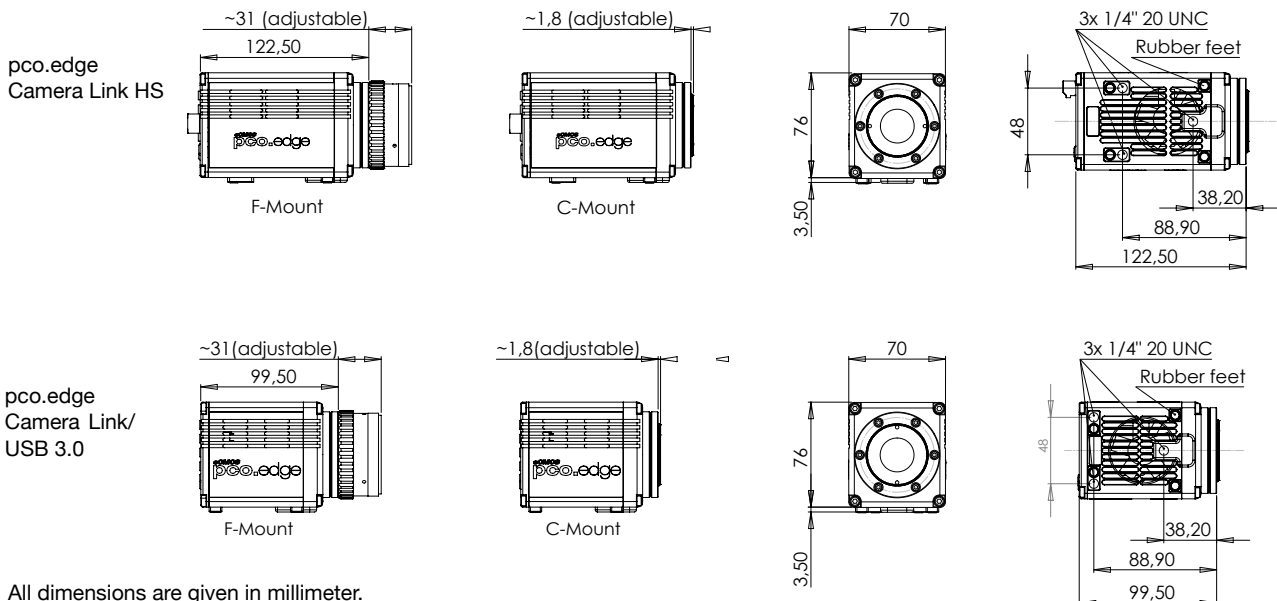

technical data

software

For camera control, image acquisition and archiving of images in various file formats PCO provides the software application Camware (Windows 7, 8 and later).

A camera SDK (software development kit) including a 32 / 64 bit dynamic link library for user customization and integration on PC platforms is available for free.

For camera interface drivers and a list of supported third party software please visit www.pco.de.

options

custom made versions (e.g. water cooling).



Water cooling unit Aquamatic II for use with pco.edge cameras.

third party integrations

software drivers



applications

life science

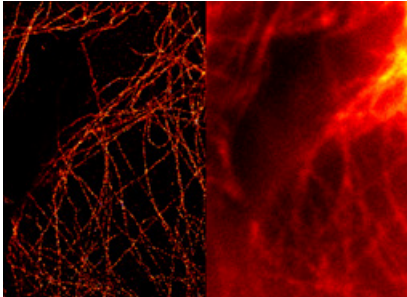

A widefield (right) and a GSDIM super-resolution (left) microscopy image of tubulin fibers obtained with a pco.edge, courtesy of Leica Microsystems, Germany

physical science

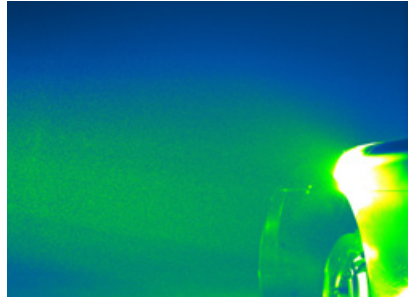

Seed particle PIV image of a wind tunnel experiment (false color rendering) to improve the aerodynamics of a racing car, courtesy of ILA GmbH & Toyota Motorsport, Germany

life science

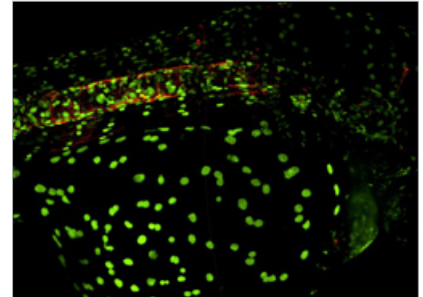

Zebrafish with two fluorescent labels, collected with a VisiScope Confocal based on the Yokogawa CSU-W1 wide head and a pco.edge camera, courtesy of VisiTron Systems GmbH, Germany

life science

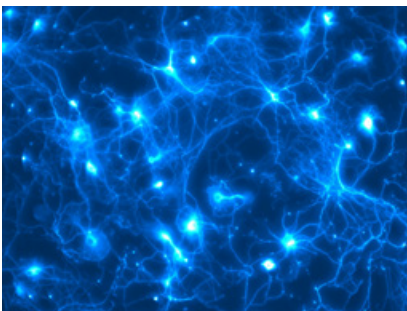

Neuronal network marked with a fluorophore (false color rendering) and recorded with a pco.edge

life science

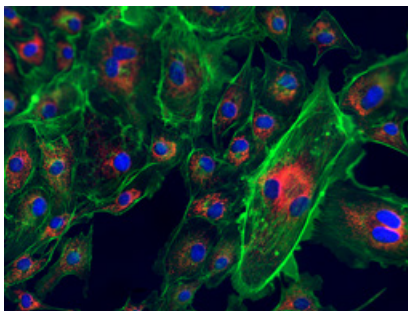

Extract of a fluorescent slide which was scanned by a pco.edge camera in a Panoramic 250 Flash scanner for digital pathology, courtesy of 3DHitech, Hungary

life science

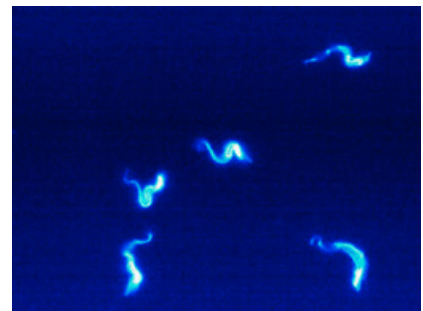

An image of a sequence, which was recorded with a pco.edge at 400 frame/s. The maximum signal was about 100 photons, courtesy of Prof. Engstler, University of Würzburg, Germany

application areas

- Widefield microscopy ■ Fluorescent microscopy ■ Digital pathology ■ PALM ■ STORM ■ GSDIM
- dSTORM ■ Superresolution microscopy ■ Lightsheet microscopy ■ Selective plane imaging microscopy (SPIM) ■ Calcium imaging ■ FRET ■ FRAP ■ 3D structured illumination microscopy ■ High speed bright field ratio imaging ■ High throughput screening ■ High content screening ■ Biochip reading ■ Particle image velocimetry (PIV) ■ TIRF ■ TIRF microscopy / waveguides ■ Spinning disk confocal microscopy ■ Live cell microscopy ■ 3D metrology ■ TV / broadcasting ■ Ophthalmology ■ Electro physiology ■ Lucky astronomy ■ Photovoltaic inspection

europa

PCO AG
Donaupark 11
93309 Kelheim, Germany

+49 9441 2005 50
info@pco.de
pco.de

america

PCO-TECH Inc.
6930 Metroplex Drive
Romulus, Michigan 48174, USA

+1 248 276 8820
info@pco-tech.com
pco-tech.com

asia

PCO Imaging Asia Pte.
3 Temasek Ave
Centennial Tower, Level 34
Singapore, 039190

+65 6549 7054
info@pco-imaging.com
pco-imaging.com

china

Suzhou PCO Imaging
Technology Co., LTD
Suzhou (Jiangsu),
P.R. China

+86 512 67634
info@pco.cn
pco.cn